

ELEVATION CERTIFICATE

Important: Follow the instructions on pages 1-9.

Copy all pages of this Elevation Certificate and all attachments for (1) community official, (2) insurance agent/company, and (3) building owner.

SECTION A – PROPERTY INFORMATION						FOR INSURANCE COMPANY USE	
A1. Building Owner's Name CFV PROPERTIES						Policy Number:	
A2. Building Street Address (including Apt., Unit, Suite, and/or Bldg. No.) or P.O. Route and Box No. 24 N. MADISON AVENUE						Company NAIC Number:	
City MARGATE		State New Jersey		ZIP Code 08402			
A3. Property Description (Lot and Block Numbers, Tax Parcel Number, Legal Description, etc.) BLOCK 230, LOT 41							
A4. Building Use (e.g., Residential, Non-Residential, Addition, Accessory, etc.) <u>RESIDENTIAL</u>							
A5. Latitude/Longitude: Lat. <u>39° 19' 18"</u> Long. <u>74° 31' 02"</u> Horizontal Datum: <input type="checkbox"/> NAD 1927 <input checked="" type="checkbox"/> NAD 1983							
A6. Attach at least 2 photographs of the building if the Certificate is being used to obtain flood insurance.							
A7. Building Diagram Number <u>7</u>							
A8. For a building with a crawlspace or enclosure(s):							
a) Square footage of crawlspace or enclosure(s) <u>953.00</u> sq ft							
b) Number of permanent flood openings in the crawlspace or enclosure(s) within 1.0 foot above adjacent grade <u>7</u>							
c) Total net area of flood openings in A8.b <u>1750.00</u> sq in							
d) Engineered flood openings? <input checked="" type="checkbox"/> Yes <input type="checkbox"/> No							
A9. For a building with an attached garage:							
a) Square footage of attached garage <u>N/A</u> sq ft							
b) Number of permanent flood openings in the attached garage within 1.0 foot above adjacent grade <u>N/A</u>							
c) Total net area of flood openings in A9.b <u>N/A</u> sq in							
d) Engineered flood openings? <input type="checkbox"/> Yes <input checked="" type="checkbox"/> No							
SECTION B – FLOOD INSURANCE RATE MAP (FIRM) INFORMATION							
B1. NFIP Community Name & Community Number MARGATE 345304				B2. County Name ATLANTIC COUNTY		B3. State New Jersey	
B4. Map/Panel Number 34001C0434	B5. Suffix F	B6. FIRM Index Date <u>8/28/2018</u>	B7. FIRM Panel Effective/ Revised Date 08-28-2018	B8. Flood Zone(s) AE	B9. Base Flood Elevation(s) (Zone AO, use Base Flood Depth) 10.00'		
B10. Indicate the source of the Base Flood Elevation (BFE) data or base flood depth entered in Item B9: <input type="checkbox"/> FIS Profile <input checked="" type="checkbox"/> FIRM <input type="checkbox"/> Community Determined <input type="checkbox"/> Other/Source: _____							
B11. Indicate elevation datum used for BFE in Item B9: <input type="checkbox"/> NGVD 1929 <input checked="" type="checkbox"/> NAVD 1988 <input type="checkbox"/> Other/Source: _____							
B12. Is the building located in a Coastal Barrier Resources System (CBRS) area or Otherwise Protected Area (OPA)? <input type="checkbox"/> Yes <input checked="" type="checkbox"/> No Designation Date: _____ <input type="checkbox"/> CBRS <input type="checkbox"/> OPA							

ELEVATION CERTIFICATE

IMPORTANT: In these spaces, copy the corresponding information from Section A.			FOR INSURANCE COMPANY USE	
Building Street Address (including Apt., Unit, Suite, and/or Bldg. No.) or P.O. Route and Box No. 24 N. MADISON AVENUE			Policy Number:	
City MARGATE	State New Jersey	ZIP Code 08402	Company NAIC Number	

SECTION C – BUILDING ELEVATION INFORMATION (SURVEY REQUIRED)

C1. Building elevations are based on: Construction Drawings* Building Under Construction* Finished Construction

*A new Elevation Certificate will be required when construction of the building is complete.

C2. Elevations – Zones A1–A30, AE, AH, A (with BFE), VE, V1–V30, V (with BFE), AR, AR/A, AR/AE, AR/A1–A30, AR/AH, AR/AO. Complete Items C2.a–h below according to the building diagram specified in Item A7. In Puerto Rico only, enter meters.

Benchmark Utilized: _____ Vertical Datum: NAVD 1988

Indicate elevation datum used for the elevations in items a) through h) below.

NGVD 1929 NAVD 1988 Other/Source: _____

Datum used for building elevations must be the same as that used for the BFE.

Check the measurement used.

- | | | | |
|---|------|--|---------------------------------|
| a) Top of bottom floor (including basement, crawlspace, or enclosure floor) _____ | 5.0 | <input checked="" type="checkbox"/> feet | <input type="checkbox"/> meters |
| b) Top of the next higher floor _____ | 14.0 | <input checked="" type="checkbox"/> feet | <input type="checkbox"/> meters |
| c) Bottom of the lowest horizontal structural member (V Zones only) _____ | N/A | <input checked="" type="checkbox"/> feet | <input type="checkbox"/> meters |
| d) Attached garage (top of slab) _____ | 5.1 | <input checked="" type="checkbox"/> feet | <input type="checkbox"/> meters |
| e) Lowest elevation of machinery or equipment servicing the building
(Describe type of equipment and location in Comments) _____ | N/A | <input checked="" type="checkbox"/> feet | <input type="checkbox"/> meters |
| f) Lowest adjacent (finished) grade next to building (LAG) _____ | 4.6 | <input checked="" type="checkbox"/> feet | <input type="checkbox"/> meters |
| g) Highest adjacent (finished) grade next to building (HAG) _____ | 5.4 | <input checked="" type="checkbox"/> feet | <input type="checkbox"/> meters |
| h) Lowest adjacent grade at lowest elevation of deck or stairs, including structural support _____ | 4.8 | <input checked="" type="checkbox"/> feet | <input type="checkbox"/> meters |

SECTION D – SURVEYOR, ENGINEER, OR ARCHITECT CERTIFICATION

This certification is to be signed and sealed by a land surveyor, engineer, or architect authorized by law to certify elevation information. I certify that the information on this Certificate represents my best efforts to interpret the data available. I understand that any false statement may be punishable by fine or imprisonment under 18 U.S. Code, Section 1001.

Were latitude and longitude in Section A provided by a licensed land surveyor? Yes No Check here if attachments.

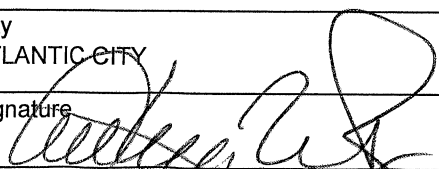
Certifier's Name ARTHUR W. PONZIO, JR.	License Number 24GS02831400	Place Seal Here	
Title PROFESSIONAL LAND SURVEYOR			
Company Name ARTHUR PONZIO CO.			
Address 400 NORTH DOVER AVENUE			
City ATLANTIC CITY	State New Jersey		ZIP Code 08401
Signature 	Date 03-08-2023	Telephone (609) 344-8194	Ext.

Copy all pages of this Elevation Certificate and all attachments for (1) community official, (2) insurance agent/company, and (3) building owner.

Comments (including type of equipment and location, per C2(e), if applicable)

PROJECT #40660-F
 HEATER: 14.03' AIR-CONDITIONER DECK: 13.50'
 FREEDOM FLOOD VENT NO.: FFV-1608

ELEVATION CERTIFICATE

OMB No. 1660-0008
Expiration Date: November 30, 2022

IMPORTANT: In these spaces, copy the corresponding information from Section A.			FOR INSURANCE COMPANY USE
Building Street Address (including Apt., Unit, Suite, and/or Bldg. No.) or P.O. Route and Box No. 24 N. MADISON AVENUE			Policy Number:
City MARGATE	State New Jersey	ZIP Code 08402	Company NAIC Number

SECTION E – BUILDING ELEVATION INFORMATION (SURVEY NOT REQUIRED) FOR ZONE AO AND ZONE A (WITHOUT BFE)

For Zones AO and A (without BFE), complete Items E1–E5. If the Certificate is intended to support a LOMA or LOMR-F request, complete Sections A, B, and C. For Items E1–E4, use natural grade, if available. Check the measurement used. In Puerto Rico only, enter meters.

- E1. Provide elevation information for the following and check the appropriate boxes to show whether the elevation is above or below the highest adjacent grade (HAG) and the lowest adjacent grade (LAG).
- a) Top of bottom floor (including basement, crawlspace, or enclosure) is _____ feet meters above or below the HAG.
- b) Top of bottom floor (including basement, crawlspace, or enclosure) is _____ feet meters above or below the LAG.
- E2. For Building Diagrams 6–9 with permanent flood openings provided in Section A Items 8 and/or 9 (see pages 1–2 of Instructions), the next higher floor (elevation C2.b in the diagrams) of the building is _____ feet meters above or below the HAG.
- E3. Attached garage (top of slab) is _____ feet meters above or below the HAG.
- E4. Top of platform of machinery and/or equipment servicing the building is _____ feet meters above or below the HAG.
- E5. Zone AO only: If no flood depth number is available, is the top of the bottom floor elevated in accordance with the community's floodplain management ordinance? Yes No Unknown. The local official must certify this information in Section G.

SECTION F – PROPERTY OWNER (OR OWNER'S REPRESENTATIVE) CERTIFICATION

The property owner or owner's authorized representative who completes Sections A, B, and E for Zone A (without a FEMA-issued or community-issued BFE) or Zone AO must sign here. The statements in Sections A, B, and E are correct to the best of my knowledge.

Property Owner or Owner's Authorized Representative's Name			
Address	City	State	ZIP Code
Signature	Date	Telephone	

Comments

Check here if attachments.

ELEVATION CERTIFICATE

OMB No. 1660-0008
Expiration Date: November 30, 2022

IMPORTANT: In these spaces, copy the corresponding information from Section A.	FOR INSURANCE COMPANY USE		
Building Street Address (including Apt., Unit, Suite, and/or Bldg. No.) or P.O. Route and Box No. 24 N. MADISON AVENUE	Policy Number:		
City MARGATE	State New Jersey	ZIP Code 08402	Company NAIC Number

SECTION G – COMMUNITY INFORMATION (OPTIONAL)

The local official who is authorized by law or ordinance to administer the community's floodplain management ordinance can complete Sections A, B, C (or E), and G of this Elevation Certificate. Complete the applicable item(s) and sign below. Check the measurement used in Items G8–G10. In Puerto Rico only, enter meters.

- G1. The information in Section C was taken from other documentation that has been signed and sealed by a licensed surveyor, engineer, or architect who is authorized by law to certify elevation information. (Indicate the source and date of the elevation data in the Comments area below.)
- G2. A community official completed Section E for a building located in Zone A (without a FEMA-issued or community-issued BFE) or Zone AO.
- G3. The following information (Items G4–G10) is provided for community floodplain management purposes.

G4. Permit Number	G5. Date Permit Issued	G6. Date Certificate of Compliance/Occupancy Issued
-------------------	------------------------	---

G7. This permit has been issued for: New Construction Substantial Improvement

G8. Elevation of as-built lowest floor (including basement) of the building: _____ feet meters Datum _____

G9. BFE or (in Zone AO) depth of flooding at the building site: _____ feet meters Datum _____

G10. Community's design flood elevation: _____ feet meters Datum _____

Local Official's Name <i>Jim Galante</i>	Title <i>CFM</i>
Community Name <i>MARGATE</i>	Telephone <i>609 822-1974</i>
Signature <i>[Signature]</i>	Date <i>4/17/23</i>

Comments (including type of equipment and location, per C2(e), if applicable)

Check here if attachments.

ELEVATION CERTIFICATE

See Instructions for Item A6.

IMPORTANT: In these spaces, copy the corresponding information from Section A.

FOR INSURANCE COMPANY USE

Building Street Address (including Apt., Unit, Suite, and/or Bldg. No.) or P.O. Route and Box No.
24 N. MADISON AVENUE

Policy Number:

City
MARGATE

State
New Jersey

ZIP Code
08402

Company NAIC Number

If using the Elevation Certificate to obtain NFIP flood insurance, affix at least 2 building photographs below according to the instructions for Item A6. Identify all photographs with date taken; "Front View" and "Rear View"; and, if required, "Right Side View" and "Left Side View." When applicable, photographs must show the foundation with representative examples of the flood openings or vents, as indicated in Section A8. If submitting more photographs than will fit on this page, use the Continuation Page.

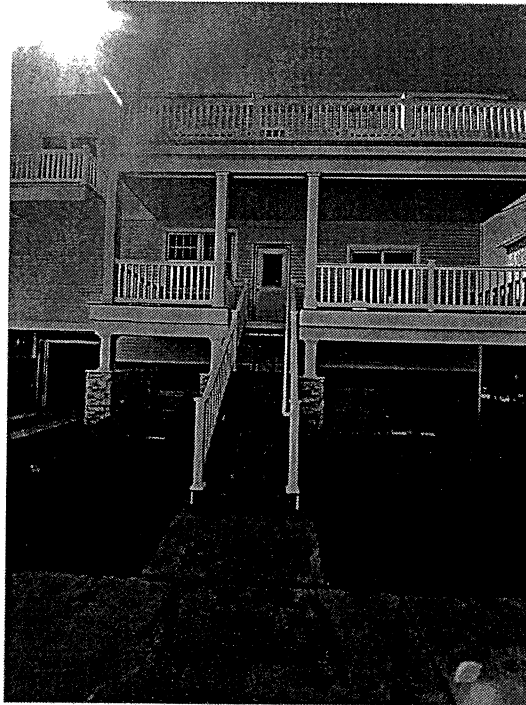

Photo One

Photo One Caption FRONT VIEW 03-08-2023

Clear Photo One

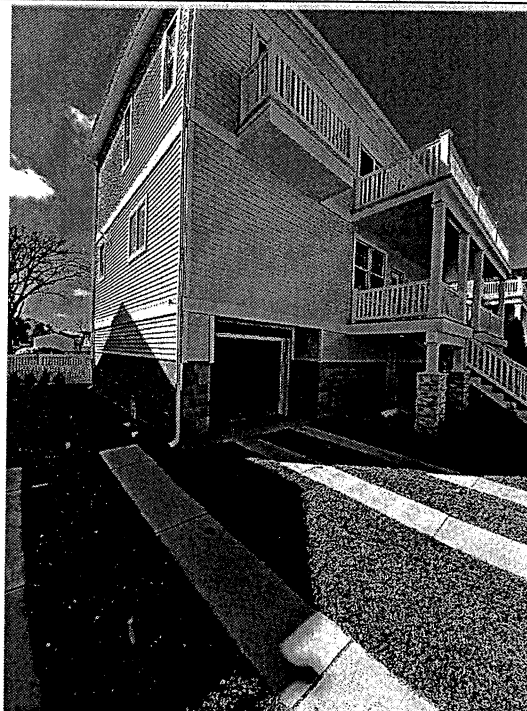

Photo Two

Photo Two Caption LEFT SIDE VIEW 03-08-2023

Clear Photo Two

ELEVATION CERTIFICATE

BUILDING PHOTOGRAPHS

Continuation Page

OMB No. 1660-0008
Expiration Date: November 30, 2022

BUILDING

IMPORTANT: In these spaces, copy the corresponding information from Section A.			FOR INSURANCE COMPANY USE
Building Street Address (including Apt., Unit, Suite, and/or Bldg. No.) or P.O. Route and Box No. 24 N. MADISON AVENUE			Policy Number:
City MARGATE	State New Jersey	ZIP Code 08402	Company NAIC Number

If submitting more photographs than will fit on the preceding page, affix the additional photographs below. Identify all photographs with: date taken; "Front View" and "Rear View"; and, if required, "Right Side View" and "Left Side View." When applicable, photographs must show the foundation with representative examples of the flood openings or vents, as indicated in Section A8.

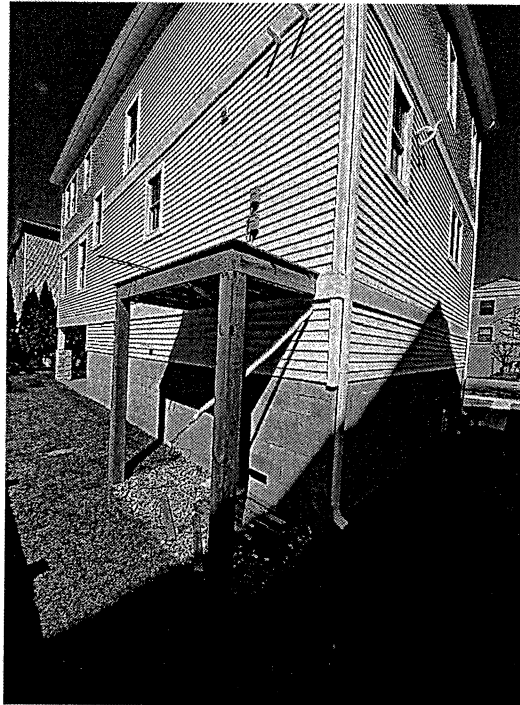

Photo Three

Photo Three Caption REAR VIEW 03-08-2023

Clear Photo Three

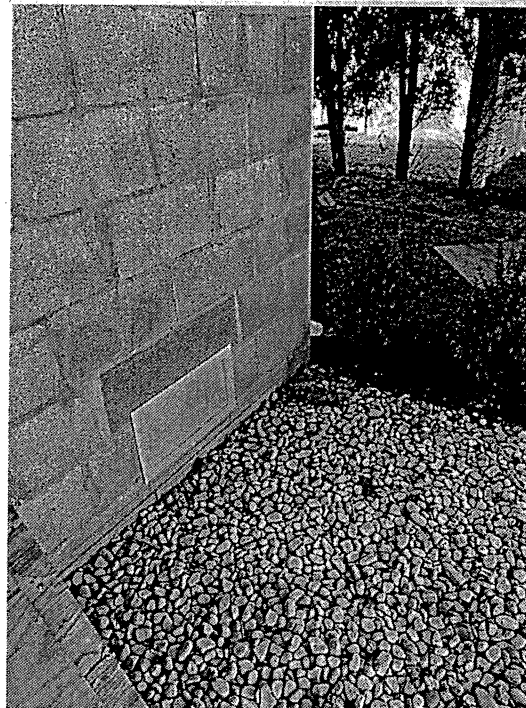
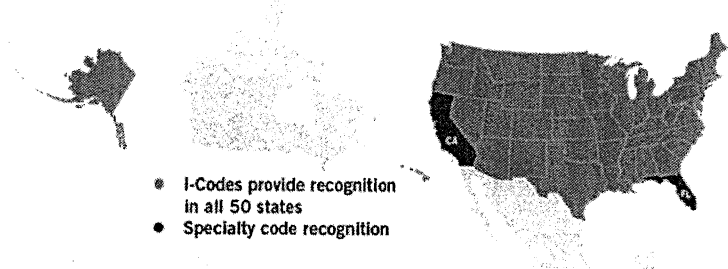

Photo Four

Photo Four Caption FREEDOM FLOOD VENT FFV-1608

Clear Photo Four



- I-Codes provide recognition in all 50 states
- Specialty code recognition

ICC-ES Evaluation Report

Reissued March 2022

ESR-4332

This report is subject to renewal March 2024.

DIVISION: 08 00 00—OPENINGS

Section: 08 95 43—Vents / Foundation Flood Vents

REPORT HOLDER:

SMART PRODUCT INNOVATIONS, INC.

EVALUATION SUBJECT:

FREEDOM FLOOD VENT™ AUTOMATIC FOUNDATION
FLOOD VENT: MODEL FFV-1608

1.0 EVALUATION SCOPE

Compliance with the following codes:

- 2021, 2018, 2015, 2012, 2009 and 2006 *International Building Code*® (IBC)
- 2021, 2018, 2015, 2012, 2009 and 2006 *International Residential Code*® (IRC)

Properties evaluated:

- Physical operation
- Water flow
- Weathering

2.0 USES

The model FFV-1608 Freedom Flood Vent™ is used to equalize hydrostatic pressure on walls of enclosures subject to rising or falling floodwaters. With the cover removed, the model FFV-1608 also provides natural air ventilation.

3.0 DESCRIPTION

3.1 General:

The model FFV-1608 Freedom Flood Vent™ is an engineered mechanically operated in-wall flood vent (FV) that automatically allows floodwater to enter an enclosed area and exit. The FV is comprised of a polycarbonate frame with mounting flange and a polycarbonate horizontally pivoting door. When subjected to rising water, the model FFV-1608 Freedom Flood Vent™ door is activated and pivots to allow water and debris to flow in either direction to equalize hydrostatic pressure from one side of the enclosure to the other. The FV features a removable polycarbonate cover. The FV door will activate and pivot when subjected to rising water with or without the polycarbonate cover installed.

3.2 Engineered Opening:

The FV complies with the design principle noted in Section 2.7.2.2 and Section 2.7.3 of ASCE/ SEI 24-14 (2021, 2018 and 2015 IBC and IRC) [Section 2.6.2.2 of ASCE/ SEI 24-05 (2012, 2009, 2006 IBC and IRC)] for a maximum rate of rise and fall of 5.0 feet per hour (0.423 mm/s). In order to comply with the engineered opening requirement of ASCE/ SEI 24, Freedom Flood Vent™ FVs must be installed in accordance with Section 4.0 below. See Table 1 for vent size and maximum allowable area coverage for a single vent.

4.0 DESIGN AND INSTALLATION

The model FFV-1608 Freedom Flood Vent™ is designed to be installed into walls or overhead doors of existing or new construction. Installation of the vent must be in accordance with the manufacturer's instructions, the applicable code, and this report. In order to comply with the engineered opening design principle noted in Sections 2.7.2.2 and 2.7.3 of ASCE/ SEI 24-14 (2021, 2018 and 2015 IBC and IRC) [Section 2.6.2.2 of ASCE/ SEI 24-05 (2012, 2009, 2006 IBC and IRC)], the Freedom Flood Vent™ must be installed as follows:

- With a minimum of two openings on different sides of each enclosed area.
- With a minimum of one FV for every 250 square feet (23.2 m²) of enclosed area.
- Below the base flood elevation.
- With the bottom of the vent located a maximum of 12 inches (305.4 mm) above the higher of the final interior grade or floor and the finished exterior grade immediately under each opening.

5.0 CONDITIONS OF USE

The Freedom Flood Vent™ described in this report complies with, or is a suitable alternative to what is specified in, those codes listed in Section 1.0 of this report, subject to the following conditions:

- 5.1 The model FFV-1608 Freedom Flood Vent™ unit must be installed in accordance with this report, the applicable code and the manufacturer's published installation instructions. In the event of a conflict, the instructions in this report shall govern.
- 5.2 The model FFV-1608 Freedom Flood Vent™ unit must not be used in place of "breakaway walls" in coastal

high hazard areas, but are permitted for use in conjunction with breakaway walls in other areas.

5.3 Use of the Freedom Flood Vent as under-floor space ventilation is outside the scope of this report.

6.0 EVIDENCE SUBMITTED

Data in accordance with the ICC-ES Acceptance Criteria for Mechanically Operated Flood Vents (AC364), dated August 2015 (editorially revised February 2021).

7.0 IDENTIFICATION

7.1 The Freedom Flood Vent™ model described in this report must be identified by a label bearing the manufacturer's name (Smart Product Innovations, Inc.) and the evaluation report number (ESR-4332).

7.2 The report holder's contact information is the following:

SMART PRODUCT INNOVATIONS, INC.
 430 ANDBRO DRIVE, UNIT 1
 PITMAN, NEW JERSEY 08071
 (800) 507-1527
www.freedomfloodvent.com
info@freedomfloodvent.co

TABLE 1—FREEDOM FLOOD VENT™

MODEL NAME	MODEL NUMBER	MODEL SIZE	COVERAGE (sq. ft.)
Freedom Flood Vent™	FFV-1608	15 ³ / ₄ " X 8 ¹ / ₁₆ "	250

For SI: 1 inch = 25.4 mm

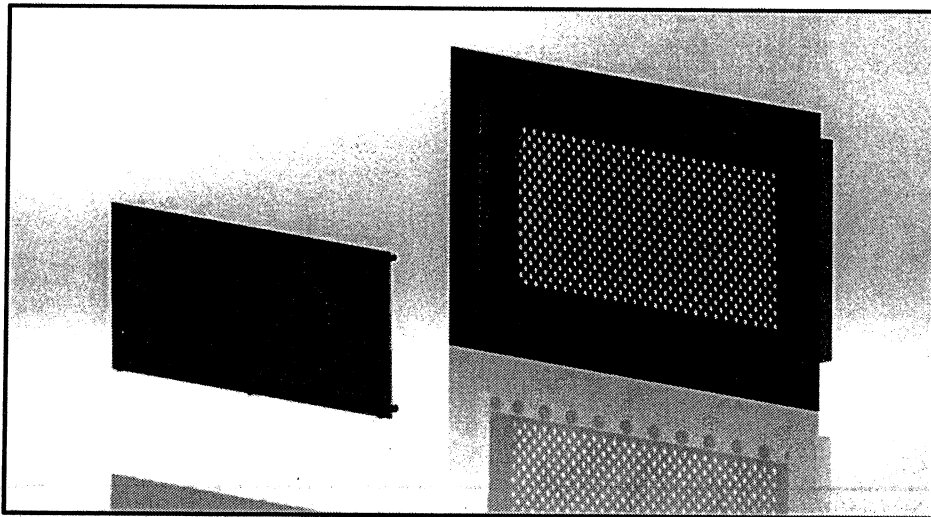

FIGURE 1—MODEL FFV-1608 FREEDOM FLOOD VENT™: SHOWN WITH COVER REMOVED

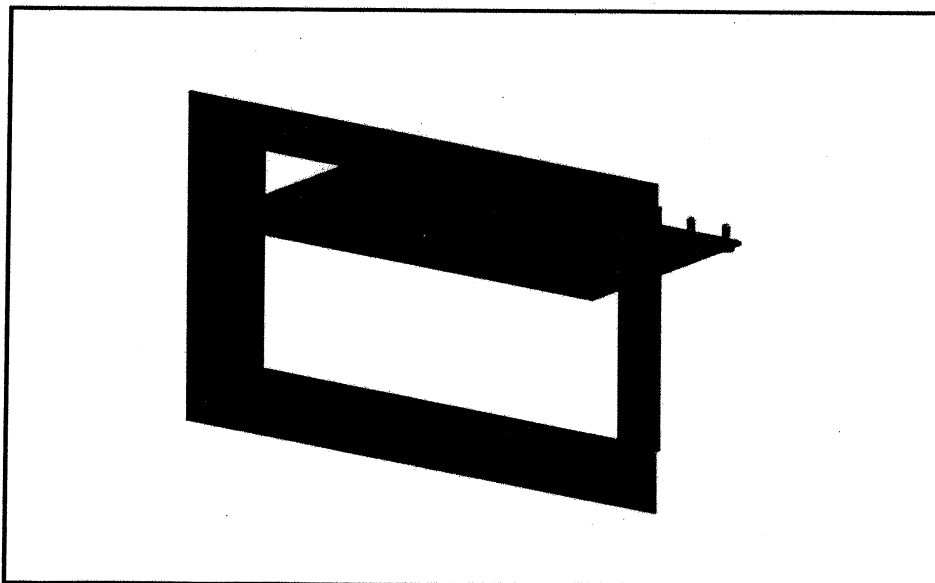

FIGURE 2—MODEL FFV-1608 FREEDOM FLOOD VENT™: SHOWN WITH FLOOD DOOR PIVOTED OPEN

DIVISION: 08 00 00—OPENINGS

Section: 08 95 43—Vents / Foundation Flood Vents

REPORT HOLDER:

SMART PRODUCT INNOVATIONS, INC.

EVALUATION SUBJECT:

FREEDOM FLOOD VENT™ AUTOMATIC FOUNDATION FLOOD VENT: MODEL FFV-1608

1.0 REPORT PURPOSE AND SCOPE

Purpose:

The purpose of this evaluation report supplement is to indicate that the Freedom Flood Vent™ Automatic Foundation Flood Vent: Model FFV-1608, described in ICC-ES evaluation report ESR-4332, has also been evaluated for compliance with codes noted below.

Applicable code editions:

- 2019 California Building Code (CBC)

For evaluation of applicable chapters adopted by the California Office of Statewide Planning and Development (OSHPD) and Division of State Architect (DSA), see Sections 2.1.1 and 2.1.2 below.

- 2019 California Residential Code (CRC)

2.0 CONCLUSIONS

2.1 CBC:

The Freedom Flood Vent™ Automatic Foundation Flood Vent: Model FFV-1608, described in Sections 2.0 through 7.0 of the evaluation report ESR-4332, complies with CBC Chapter 12 provided the design and installation are in accordance with the 2018 *International Building Code*® (IBC) provisions noted in the evaluation report and the additional requirements of CBC Chapters 12 and 16, as applicable.

2.1.1 OSHPD: The applicable OSHPD Sections and Chapters of the CBC are beyond the scope of this supplement.

2.1.2 DSA: The applicable DSA Sections and Chapters of the CBC are beyond the scope of this supplement.

2.2 CRC:

The Freedom Flood Vent™ Automatic Foundation Flood Vent: Model FFV-1608, described in Sections 2.0 through 7.0 of the evaluation report ESR-4332, complies with the 2019 CRC, provided the design and installation are in accordance with the 2018 *International Residential Code*® (IRC) provisions noted in the evaluation report.

This supplement expires concurrently with the evaluation report, reissued March 2022.

DIVISION: 08 00 00—OPENINGS

Section: 08 95 43—Vents / Foundation Flood Vents

REPORT HOLDER:

SMART PRODUCT INNOVATIONS, INC.

EVALUATION SUBJECT:

FREEDOM FLOOD VENT™ AUTOMATIC FOUNDATION FLOOD VENT: MODEL FFV-1608

1.0 REPORT PURPOSE AND SCOPE

Purpose:

The purpose of this evaluation report supplement is to indicate that Freedom Flood Vent™ Automatic Foundation Flood Vent: Model FFV-1608, described in ICC-ES evaluation report ESR-4332, has also been evaluated for compliance with the codes noted below.

Applicable code editions:

- 2020 Florida Building Code—Building
- 2020 Florida Building Code—Residential

2.0 CONCLUSIONS

The Freedom Flood Vent™ Automatic Foundation Flood Vent: Model FFV-1608, described in Sections 2.0 through 7.0 of the evaluation report ESR-4332, complies with the *Florida Building Code—Building* and the *Florida Building Code—Residential*, provided the design requirements are determined in accordance with the *Florida Building Code—Building* and the *Florida Building Code—Residential*, as applicable. The installation requirements noted in ICC-ES evaluation report ESR-4332 for the 2018 *International Building Code*® (IBC) meet the requirements of *Florida Building Code—Building* and the *Florida Building Code—Residential*, as applicable.

Use of the Freedom Flood Vent™ Automatic Foundation Flood Vent: Model FFV-1608 has also been found to be in compliance with the High-Velocity Hurricane Zone provisions of the *Florida Building Code—Building* and the *Florida Building Code—Residential*.

For products falling under Florida Rule 61G20-3, verification that the report holder's quality assurance program is audited by a quality assurance entity approved by the Florida Building Commission for the type of inspections being conducted is the responsibility of an approved validation entity (or the code official, when the report holder does not possess an approval by the Commission).

This supplement expires concurrently with the evaluation report, reissued March 2022.